

INSTRUCTION MANUAL

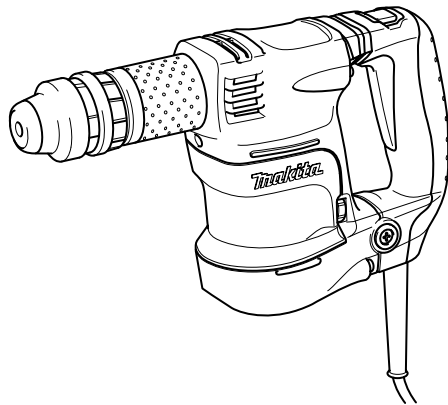

Power Scraper

HK1820

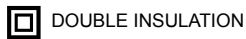

008522

**⚠WARNING:**

For your personal safety, READ and UNDERSTAND before using.
SAVE THESE INSTRUCTIONS FOR FUTURE REFERENCE.

ENGLISH

SPECIFICATIONS

Model	HK1820
Blows per minute (min ⁻¹)	0 - 3,200
Overall length	351 mm
Net weight	3.3 kg
Safety class	Ⓜ II

- Due to our continuing programme of research and development, the specifications herein are subject to change without notice.
- Note: Specifications may differ from country to country.

END201-4

ENG215-1

Symbols

The following show the symbols used for the equipment. Be sure that you understand their meaning before use.



- Read instruction manual.



- DOUBLE INSULATION



- Only for EU countries
Do not dispose of electric equipment together with household waste material! In observance of European Directive 2002/96/EC on waste electric and electronic equipment and its implementation in accordance with national law, electric equipment that have reached the end of their life must be collected separately and returned to an environmentally compatible recycling facility.

ENE047-1

Intended use

The tool is intended for chiselling work in concrete, brick and stone as well as for driving and compacting with appropriate accessories.

ENF002-1

Power supply

The tool should be connected only to a power supply of the same voltage as indicated on the nameplate, and can only be operated on single-phase AC supply. They are double-insulated in accordance with European Standard and can, therefore, also be used from sockets without earth wire.

ENG101-1

For European countries only

Noise

The typical A-weighted noise level determined according to EN60745-2-6:

Sound pressure level (L_{pA}) : 83 dB(A)

Uncertainty (K) : 3 dB(A)

The noise level under working may exceed 85 dB (A).

Wear ear protection.

Vibration

The vibration total value (tri-axial vector sum) determined according to EN60745-2-6:

Work mode : chiseling function

Vibration emission ($a_{h,CHeg}$) : 10 m/s²

Uncertainty (K) : 1.5 m/s²

ENH101-8

EC-DECLARATION OF CONFORMITY

Model; HK1820

We declare under our sole responsibility that this product is in compliance with the following standards of standardized documents;

EN60745, EN55014, EN61000 in accordance with Council Directives, 2004/108/EC, 98/37/EC.

CE2007

000230

Tomoyasu Kato
Director

Responsible Manufacturer:

Makita Corporation

3-11-8, Sumiyoshi-cho, Anjo, Aichi, JAPAN

Authorized Representative in Europe:

Makita International Europe Ltd.

Michigan Drive, Tongwell, Milton Keynes, Bucks MK15 8JD, ENGLAND

GEA005-1

General Power Tool Safety

Warnings

⚠ WARNING Read all safety warnings and all instructions. Failure to follow the warnings and instructions may result in electric shock, fire and/or serious injury.

Save all warnings and instructions for future reference.

Work area safety

1. **Keep work area clean and well lit.** Cluttered or dark areas invite accidents.
2. **Do not operate power tools in explosive**

atmospheres, such as in the presence of flammable liquids, gases or dust. Power tools create sparks which may ignite the dust or fumes.

3. **Keep children and bystanders away while operating a power tool.** Distractions can cause you to lose control.

Electrical Safety

4. **Power tool plugs must match the outlet. Never modify the plug in any way. Do not use any adapter plugs with earthed (grounded) power tools.** Unmodified plugs and matching outlets will reduce risk of electric shock.
5. **Avoid body contact with earthed or grounded surfaces such as pipes, radiators, ranges and refrigerators.** There is an increased risk of electric shock if your body is earthed or grounded.
6. **Do not expose power tools to rain or wet conditions.** Water entering a power tool will increase the risk of electric shock.
7. **Do not abuse the cord. Never use the cord for carrying, pulling or unplugging the power tool. Keep cord away from heat, oil, sharp edges or moving parts.** Damaged or entangled cords increase the risk of electric shock.
8. **When operating a power tool outdoors, use an extension cord suitable for outdoor use.** Use of a cord suitable for outdoor use reduces the risk of electric shock.
9. **If operating a power tool in a damp location is unavoidable, use a ground fault circuit interrupter (GFCI) protected supply.** Use of an GFCI reduces the risk of electric shock.

Personal Safety

10. **Stay alert, watch what you are doing and use common sense when operating a power tool. Do not use a power tool while you are tired or under the influence of drugs, alcohol or medication.** A moment of inattention while operating power tools may result in serious personal injury.
11. **Use personal protective equipment. Always wear eye protection.** Protective equipment such as dust mask, non-skid safety shoes, hard hat, or hearing protection used for appropriate conditions will reduce personal injuries.
12. **Prevent unintentional starting. Ensure the switch is in the off-position before connecting to power source and/or battery pack, picking up or carrying the tool.** Carrying power tools with your finger on the switch or energising power tools that have the switch on invites accidents.
13. **Remove any adjusting key or wrench before turning the power tool on.** A wrench or a key left attached to a rotating part of the power tool may result in personal injury.

14. **Do not overreach. Keep proper footing and balance at all times.** This enables better control of the power tool in unexpected situations.
15. **Dress properly. Do not wear loose clothing or jewellery. Keep your hair, clothing, and gloves away from moving parts.** Loose clothes, jewellery or long hair can be caught in moving parts.
16. **If devices are provided for the connection of dust extraction and collection facilities, ensure these are connected and properly used.** Use of dust collection can reduce dust-related hazards.

Power tool use and care

17. **Do not force the power tool. Use the correct power tool for your application.** The correct power tool will do the job better and safer at the rate for which it was designed.
18. **Do not use the power tool if the switch does not turn it on and off.** Any power tool that cannot be controlled with the switch is dangerous and must be repaired.
19. **Disconnect the plug from the power source and/or the battery pack from the power tool before making any adjustments, changing accessories, or storing power tools.** Such preventive safety measures reduce the risk of starting the power tool accidentally.
20. **Store idle power tools out of the reach of children and do not allow persons unfamiliar with the power tool or these instructions to operate the power tool.** Power tools are dangerous in the hands of untrained users.
21. **Maintain power tools. Check for misalignment or binding of moving parts, breakage of parts and any other condition that may affect the power tool's operation. If damaged, have the power tool repaired before use.** Many accidents are caused by poorly maintained power tools.
22. **Keep cutting tools sharp and clean.** Properly maintained cutting tools with sharp cutting edges are less likely to bind and are easier to control.
23. **Use the power tool, accessories and tool bits etc. in accordance with these instructions, taking into account the working conditions and the work to be performed.** Use of the power tool for operations different from those intended could result in a hazardous situation.

SERVICE

24. **Have your power tool serviced by a qualified repair person using only identical replacement parts.** This will ensure that the safety of the power tool is maintained.
25. **Follow instruction for lubricating and changing accessories.**

26. **Keep handles dry, clean and free from oil and grease.**

GEB004-2

SPECIFIC SAFETY RULES

DO NOT let comfort or familiarity with product (gained from repeated use) replace strict adherence to hammer safety rules. If you use this tool unsafely or incorrectly, you can suffer serious personal injury.

1. **Wear ear protectors.** Exposure to noise can cause hearing loss.
2. **Use auxiliary handles supplied with the tool.** Loss of control can cause personal injury.
3. **Hold power tools by insulated gripping surfaces when performing an operation where the cutting tool may contact hidden wiring or its own cord.** Contact with a "live" wire will make exposed metal parts of the tool "live" and shock the operator.
4. **Wear a hard hat (safety helmet), safety glasses and/or face shield.** Ordinary eye or sun glasses are **NOT** safety glasses. It is also highly recommended that you wear a dust mask and thickly padded gloves.
5. **Be sure the bit is secured in place before operation.**
6. **Under normal operation, the tool is designed to produce vibration.** The screws can come loose easily, causing a breakdown or accident. Check tightness of screws carefully before operation.
7. **In cold weather or when the tool has not been used for a long time, let the tool warm up for a while by operating it under no load.** This will loosen up the lubrication. Without proper warm-up, hammering operation is difficult.
8. **Always be sure you have a firm footing.** Be sure no one is below when using the tool in high locations.
9. **Hold the tool firmly with both hands.**
10. **Keep hands away from moving parts.**
11. **Do not leave the tool running.** Operate the tool only when hand-held.
12. **Do not point the tool at any one in the area when operating.** The bit could fly out and injure someone seriously.
13. **Do not touch the bit or parts close to the bit immediately after operation; they may be extremely hot and could burn your skin.**
14. **Do not operate the tool at no-load unnecessarily.**
15. **Some material contains chemicals which may be toxic.** Take caution to prevent dust inhalation and skin contact. Follow material

supplier safety data.

SAVE THESE INSTRUCTIONS.

⚠WARNING:

MISUSE or failure to follow the safety rules stated in this instruction manual may cause serious personal injury.

FUNCTIONAL DESCRIPTION

⚠CAUTION:

- Always be sure that the tool is switched off and unplugged before adjusting or checking function on the tool.

Switch action

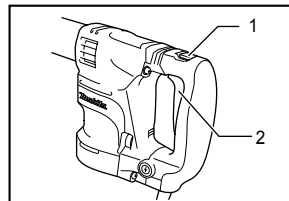

1. Lock button
2. Switch trigger

008523

⚠CAUTION:

- Before plugging in the tool, always check to see that the switch trigger actuates properly and returns to the "OFF" position when released.

To start the tool, simply pull the switch trigger. Tool speed is increased by increasing pressure on the switch trigger. Release the switch trigger to stop.

For continuous operation, pull the switch trigger and then push in the lock button.

To stop the tool from the locked position, pull the switch trigger fully, then release it.

Speed change

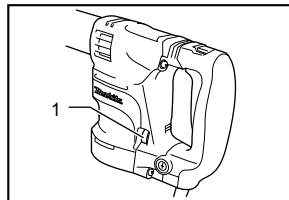

1. Adjusting dial

008524

The blows per minute can be adjusted just by turning the adjusting dial. This can be done even while the tool is running. The dial is marked 1 (lowest speed) to 5 (full speed).

Refer to the table below for the relationship between the number settings on the adjusting dial and the blows per minute.

Number on adjusting dial	Blows per minute
5	3,200
4	2,900
3	2,600
2	2,300
1	2,000

008531

⚠ CAUTION:

- The speed adjusting dial can be turned only as far as 5 and back to 1. Do not force it past 5 or 1, or the speed adjusting function may no longer work.

ASSEMBLY

⚠ CAUTION:

- Always be sure that the tool is switched off and unplugged before carrying out any work on the tool.

Installing or removing the bit

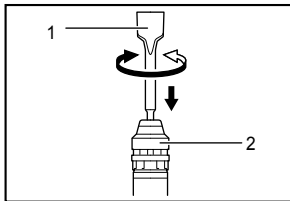

008525

1. Bit
2. Chuck cover

Clean the bit shank before installing the bit. Insert the bit into the tool. Turn the bit and push it in until it engages.

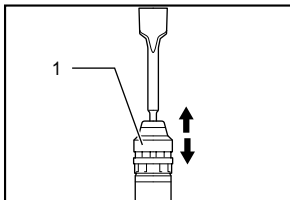

008528

1. Chuck cover

If the bit cannot be pushed in, remove the bit. Pull the chuck cover down a couple of times. Then insert the bit again. Turn the bit and push it in until it engages.

After installing, always make sure that the bit is securely held in place by trying to pull it out.

To remove the bit, pull the chuck cover down all the way and pull the bit out.

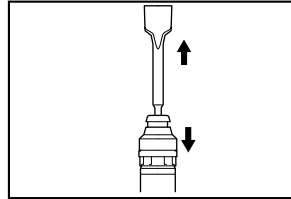

008529

Bit angle

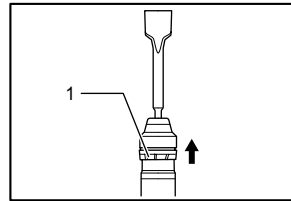

008532

1. Change ring

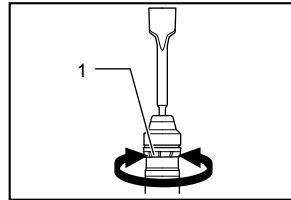

008533

1. Change ring

The bit can be secured at 12 different angles. To change the bit angle, slide the change ring forward, then turn the change ring to change the bit angle. At the desired angle, slide the change ring back to the original position. The bit will be secured in place.

Hook

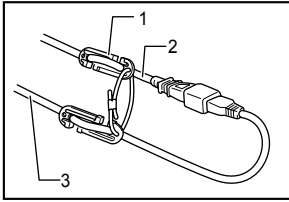

008530

1. Hook
2. Power supply cord
3. Extension cord

When connecting the power supply cord to an extension cord, use the hook so that the plug of power supply cord cannot be disconnected from the connector of extension cord. Set it on the extension cord 10 cm - 20 cm away from the connector of the extension cord.

OPERATION

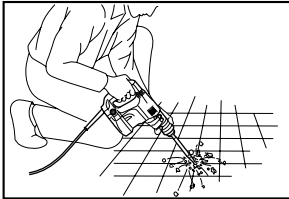

008527

Position the bit at the location to be chipped, then pull the switch trigger. Apply slight pressure on the tool so that the tool will not bounce around, uncontrolled. Pressing very hard on the tool will not increase the efficiency.

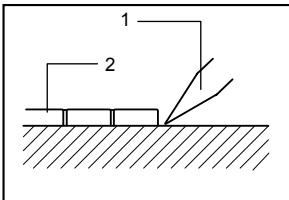

002941

1. Scaling chisel
2. Tile

NOTE:

- When removing tiles with a scaling chisel, apply the chisel to the bottom of tiles as shown in the figure. If you operate the tool with the chisel applied to the top surface of tiles, the service life of the chisel will be shortened.

MAINTENANCE

⚠CAUTION:

- Always be sure that the tool is switched off and unplugged before attempting to perform inspection or maintenance.

To maintain product SAFETY and RELIABILITY, repairs, carbon brush inspection and replacement, any other maintenance or adjustment should be performed by Makita Authorized Service Centers, always using Makita replacement parts.

ACCESSORIES

⚠CAUTION:

- These accessories or attachments are recommended for use with your Makita tool specified in this manual. The use of any other accessories or attachments might present a risk of injury to persons. Only use accessory or attachment for its stated purpose.

If you need any assistance for more details regarding these accessories, ask your local Makita Service Center.

- Bull point
- Cold chisel
- Scaling chisel
- Bit grease
- Safety goggles
- Hammer grease
- Hook

Makita Corporation Anjo, Aichi, Japan