

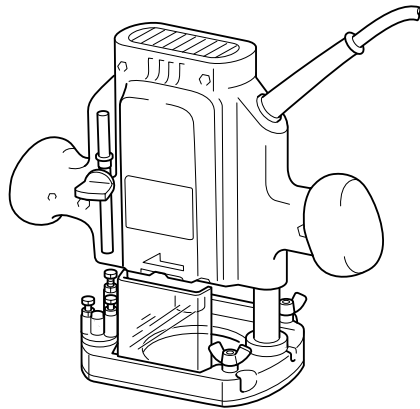

Router

MODEL 3620



003251



I N S T R U C T I O N M A N U A L

⚠ WARNING:

For your personal safety, READ and UNDERSTAND before using.
SAVE THESE INSTRUCTIONS FOR FUTURE REFERENCE.

SPECIFICATIONS

Model	3620
Collet capacity	1/4"
Plunge capacity	35 mm (1 - 3/8")
No load speed (RPM)	29,000/min.
Overall length	211 mm (8 - 5/16")
Net weight	2.4 kg (5.3 lbs)

- Manufacturer reserves the right to change specifications without notice.
- Specifications may differ from country to country.

GENERAL SAFETY RULES

USA002-2

(For All Tools)

⚠ WARNING:

Read and understand all instructions. Failure to follow all instructions listed below, may result in electric shock, fire and/or serious personal injury.

SAVE THESE INSTRUCTIONS

Work Area

1. **Keep your work area clean and well lit.** Cluttered benches and dark areas invite accidents.
2. **Do not operate power tools in explosive atmospheres, such as in the presence of flammable liquids, gases, or dust.** Power tools create sparks which may ignite the dust or fumes.
3. **Keep bystanders, children, and visitors away while operating a power tool.** Distractions can cause you to lose control.

Electrical Safety

4. **Double insulated tools are equipped with a polarized plug (one blade is wider than the other.) This plug will fit in a polarized outlet only one way. If the plug does not fit fully in the outlet, reverse the plug. If it still does not fit, contact a qualified electrician to install a polarized outlet. Do not change the plug in any way.** Double insulation  eliminates the need for the three wire grounded power cord and grounded power supply system.

-
5. **Avoid body contact with grounded surfaces such as pipes, radiators, ranges and refrigerators.** There is an increased risk of electric shock if your body is grounded.
 6. **Do not expose power tools to rain or wet conditions.** Water entering a power tool will increase the risk of electric shock.
 7. **Do not abuse the cord. Never use the cord to carry the tools or pull the plug from an outlet. Keep cord away from heat, oil, sharp edges or moving parts. Replace damaged cords immediately.** Damaged cords increase the risk of electric shock.
 8. **When operating a power tool outside, use an outdoor extension cord marked “W-A” or “W”.** These cords are rated for outdoor use and reduce the risk of electric shock.

Personal Safety

9. **Stay alert, watch what you are doing and use common sense when operating a power tool. Do not use tool while tired or under the influence of drugs, alcohol, or medication.** A moment of inattention while operating power tools may result in serious personal injury.
10. **Dress properly. Do not wear loose clothing or jewelry. Contain long hair. Keep your hair, clothing, and gloves away from moving parts.** Loose clothes, jewelry, or long hair can be caught in moving parts.
11. **Avoid accidental starting. Be sure switch is off before plugging in.** Carrying tools with your finger on the switch or plugging in tools that have the switch on invites accidents.
12. **Remove adjusting keys or wrenches before turning the tool on.** A wrench or a key that is left attached to a rotating part of the tool may result in personal injury.
13. **Do not overreach. Keep proper footing and balance at all times.** Proper footing and balance enables better control of the tool in unexpected situations.
14. **Use safety equipment. Always wear eye protection.** Dust mask, non-skid safety shoes, hard hat, or hearing protection must be used for appropriate conditions. Ordinary eye or sun glasses are NOT eye protection.

Tool Use and Care

15. **Use clamps or other practical way to secure and support the workpiece to a stable platform.** Holding the work by hand or against your body is unstable and may lead to loss of control.
16. **Do not force tool. Use the correct tool for your application.** The correct tool will do the job better and safer at the rate for which it is designed.
17. **Do not use tool if switch does not turn it on or off.** Any tool that cannot be controlled with the switch is dangerous and must be repaired.
18. **Disconnect the plug from the power source before making any adjustments, changing accessories, or storing the tool.** Such preventive safety measures reduce the risk of starting the tool accidentally.
19. **Store idle tools out of reach of children and other untrained persons.** Tools are dangerous in the hands of untrained users.
20. **Maintain tools with care. Keep cutting tools sharp and clean.** Properly maintained tools with sharp cutting edges are less likely to bind and are easier to control.
21. **Check for misalignment or binding of moving parts, breakage of parts, and any other condition that may affect the tools operation. If damaged, have the tool serviced before using.** Many accidents are caused by poorly maintained tools.
22. **Use only accessories that are recommended by the manufacturer for your model.** Accessories that may be suitable for one tool, may become hazardous when used on another tool.

SERVICE

23. Tool service must be performed only by qualified repair personnel. Service or maintenance performed by unqualified personnel could result in a risk of injury.

24. When servicing a tool, use only identical replacement parts. Follow instructions in the Maintenance section of this manual. Use of unauthorized parts or failure to follow Maintenance instructions may create a risk of electric shock or injury.

USE PROPER EXTENSION CORD: Make sure your extension cord is in good condition. When using an extension cord, be sure to use one heavy enough to carry the current your product will draw. An undersized cord will cause a drop in line voltage resulting in loss of power and overheating. Table 1 shows the correct size to use depending on cord length and nameplate ampere rating. If in doubt, use the next heavier gage. The smaller the gage number, the heavier the cord.

Table 1: Minimum gage for cord

Ampere Rating		Volts	Total length of cord in feet			
		120 V	25 ft.	50 ft.	100 ft.	150 ft.
More Than	Not More Than	AWG				
0	6		18	16	16	14
6	10		18	16	14	12
10	12		16	16	14	12
12	16		14	12	Not Recommended	

SPECIFIC SAFETY RULES

USB013-3

DO NOT let comfort or familiarity with product (gained from repeated use) replace strict adherence to router safety rules. If you use this tool unsafely or incorrectly, you can suffer serious personal injury.

- 1. Hold tool by insulated gripping surfaces when performing an operation where the cutting tool may contact hidden wiring or its own cord.** Contact with a “live” wire will make exposed metal parts of the tool “live” and shock the operator.
- 2. Wear hearing protection during extended period of operation.**
- 3. Handle the bits very carefully.**
- 4. Check the bit carefully for cracks or damage before operation. Replace cracked or damaged bit immediately.**
- 5. Avoid cutting nails. Inspect for and remove all nails from the workpiece before operation.**
- 6. Hold the tool firmly with both hands.**
- 7. Keep hands away from rotating parts.**
- 8. Make sure the bit is not contacting the workpiece before the switch is turned on.**

-
9. Before using the tool on an actual workpiece, let it run for a while. Watch for vibration or wobbling that could indicate improperly installed bit.
 10. Be careful of the bit rotating direction and the feed direction.
 11. Do not leave the tool running. Operate the tool only when hand-held.
 12. Always switch off and wait for the bit to come to a complete stop before removing the tool from workpiece.
 13. Do not touch the bit immediately after operation; it may be extremely hot and could burn your skin.
 14. Always lead the power supply cord away from the tool towards the rear.
 15. Do not smear the tool base carelessly with thinner, gasoline, oil or the like. They may cause cracks in the tool base.
 16. Draw attention to the need to use cutters of the correct shank diameter and suitable for the speed of the tool.
 17. Some material contains chemicals which may be toxic. Take caution to prevent dust inhalation and skin contact. Follow material supplier safety data.

SAVE THESE INSTRUCTIONS

⚠ WARNING:
MISUSE or failure to follow the safety rules stated in this instruction manual may cause serious personal injury.

SYMBOLS

USD201-2

The followings show the symbols used for tool.

V volts

A amperes

Hz hertz

 alternating current

n. no load speed

 Class II Construction

.../min..... revolutions or reciprocation per minute

FUNCTIONAL DESCRIPTION

⚠ CAUTION:

- Always be sure that the tool is switched off and unplugged before adjusting or checking function on the tool.

Adjusting the depth of cut

Place the tool on a flat surface. Loosen the screw securing the stopper pole.

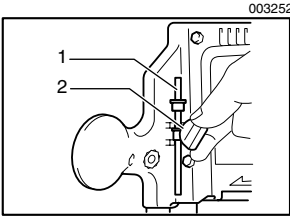

1. Stopper pole
2. Screw

Loosen the lock lever and lower the tool body until the bit just touches the flat surface. Tighten the lock lever to lock the tool body.

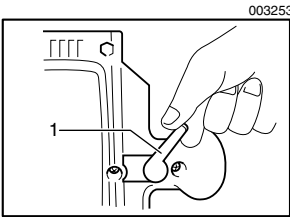

1. Lock lever

Next, lower the stopper pole until it makes contact with the adjusting hex bolt. Align the depth pointer with the "0" graduation.

Raise the stopper pole until the desired depth of cut is obtained. The depth of cut is indicated on the scale (1 mm or 1/16" per graduation) by the depth pointer. Then tighten the screw to secure the stopper pole.

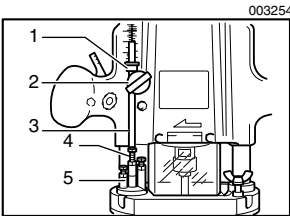

1. Depth pointer
2. Screw
3. Stopper pole
4. Adjusting hex bolt
5. Stopper block

Now, your predetermined depth of cut can be obtained by loosening the lock lever and then lowering the tool body until the stopper pole makes contact with the adjusting hex bolt.

⚠ CAUTION:

- Since excessive cutting may cause overload of the motor or difficulty in controlling the tool, the depth of cut should not be more than 15 mm (9/16") at a pass when cutting grooves with an 8 mm (5/16") diameter bit. (Note: When cutting grooves with a 20 mm (13/16") diameter bit, the depth of cut should not be more than 5 mm (3/16") at a pass.)

When you wish to cut grooves more than 15 mm (9/16")

deep with an 8 mm (5/16") diameter bit or more than 5 mm (3/16") deep with a 20 mm (13/16") diameter bit, make several passes with progressively deeper bit settings.

Stopper block

The stopper block has three adjusting hex bolts which raise or lower 0.8 mm (about 1/32") per turn. You can easily obtain three different depths of cut using these adjusting hex bolts without readjusting the stopper pole.

Adjust the lowest hex bolt to obtain the deepest depth of cut, following the method of "Adjusting depth of cut". Adjust the two remaining hex bolts to obtain shallower depths of cut. The differences in height of these hex bolts are equal to the differences in depths of cut.

To adjust the hex bolts, first loosen the hex nuts on the hex bolts with the wrench and then turn the hex bolts. After obtaining the desired position, tighten the hex nuts while holding the hex bolts in that desired position. The stopper block is also convenient for making three passes with progressively deeper bit settings when cutting deep grooves.

⚠ CAUTION:

- When using a bit having total length of 60 mm (2 - 3/8") or more, or edge length of 35 mm (1 - 3/8") or more, the depth of cut cannot be adjusted as previously mentioned. To adjust, proceed as follows:

Loosen the lock lever and carefully adjust bit protrusion below the tool base to the desired depth of cut by moving the tool body up or down. Then re-tighten the lock lever to lock the tool body at that depth of cut. Keep the tool body locked at this position during use. Since the bit always protrudes from the tool base, be careful when handling the tool.

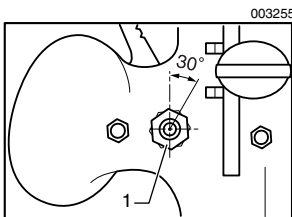

1. Hex nut

Adjusting the lock lever

The locked position of the lock lever is adjustable. To adjust it, loosen the lock lever 3/4 turn and press the center of the lock lever. The hex nut will come out. Set the hex nut to the desired position and tighten the lock lever.

003256

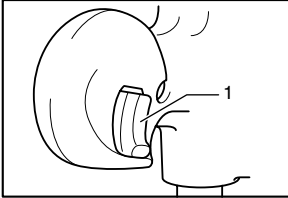

1. Switch trigger

Switch action

⚠ CAUTION:

- Before plugging in the tool, always check to see that the switch trigger actuates properly and returns to the “OFF” position when released.

To start the tool, simply pull the switch trigger. Release the switch trigger to stop.

ASSEMBLY

003257

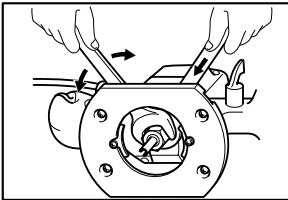

Installing or removing router bit

Insert the bit all the way into the collet cone and tighten the collet nut securely with the two wrenches.

To remove the bit, follow the installation procedure in reverse.

⚠ CAUTION:

- Do not tighten the collet nut without inserting a bit, or the collet cone will break.

003258

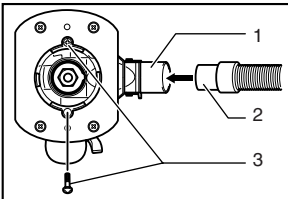

1. Dust nozzle
2. Hose of vacuum cleaner
3. Screws

Dust nozzle (optional accessory)

When you wish to perform clean cutting operation, use the dust nozzle. Install the dust nozzle on the router base using the two screws and connect a vacuum cleaner to the dust nozzle.

OPERATION

Set the tool base on the workpiece to be cut without the bit making any contact. Then turn the tool on and wait until the bit attains full speed. Lower the tool body and move the tool forward over the workpiece surface, keeping the tool base flush and advancing smoothly until the cutting is complete.

When doing edge cutting, the workpiece surface should be on the left side of the bit in the feed direction.

001984

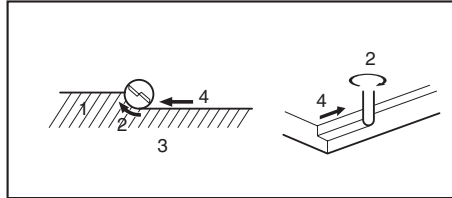

1. Workpiece
2. Bit revolving direction
3. View from the top of the tool
4. Feed direction

NOTE:

- Moving the tool forward too fast may cause a poor quality of cut, or damage to the bit or motor. Moving the tool forward too slowly may burn and mar the cut. The proper feed rate will depend on the bit size, the kind of workpiece and depth of cut. Before beginning the cut on the actual workpiece, it is advisable to make a sample cut on a piece of scrap lumber. This will show exactly how the cut will look as well as enable you to check dimensions.
- When using the straight guide, be sure to install it on the right side in the feed direction. This will help to keep it flush with the side of the workpiece.

003259

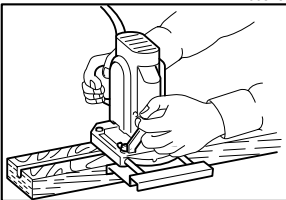

Straight guide

The straight guide is effectively used for straight cuts when chamfering or grooving.

003260

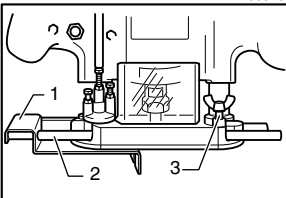

1. Straight guide
2. Guide bar
3. Wing bolt

To install the straight guide, insert the guide bars into the holes in the tool base. Adjust the distance between the bit and the straight guide. At the desired distance, tighten the wing bolts to secure the straight guide in place.

003261

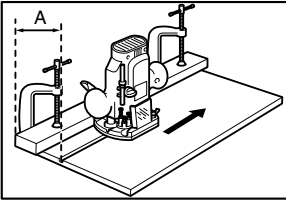

When cutting, move the tool with the straight guide flush with the side of the workpiece. If the distance (A) between the side of the workpiece and the cutting position is too wide for the straight guide, or if the side of the workpiece is not straight, the straight guide cannot be used. In this case, firmly clamp a straight board to the workpiece and use it as a guide against the router base. Feed the tool in the direction of the arrow.

003262

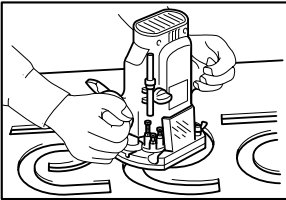

Templet guide (optional accessory)

The templet guide provides a sleeve through which the bit passes, allowing use of the router with templet patterns.

003263

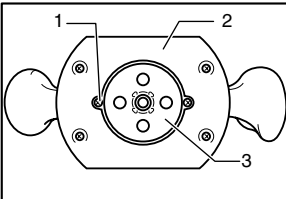

To install the templet guide, loosen the screws on the tool base, insert the templet guide and then tighten the screws.

1. Screw
2. Base plate
3. Templet guide

003264

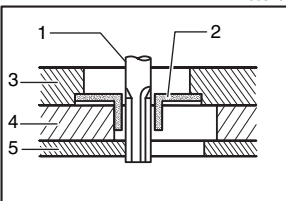

Secure the templet to the workpiece. Place the tool on the templet and move the tool with the templet guide sliding along the side of the templet.

1. Bit
2. Templet guide
3. Base
4. Templet
5. Workpiece

MAINTENANCE

⚠ CAUTION:

- Always be sure that the tool is switched off and unplugged before attempting to perform inspection or maintenance.

To maintain product SAFETY and RELIABILITY, repairs, carbon brush inspection and replacement, any other maintenance or adjustment should be performed by Makita Authorized or Factory Service Centers, always using Makita replacement parts.

ACCESSORIES

⚠ CAUTION:

- These accessories or attachments are recommended for use with your Makita tool specified in this manual. The use of any other accessories or attachments might present a risk of injury to persons. Only use accessory or attachment for its stated purpose.

If you need any assistance for more details regarding these accessories, ask your local Makita service center.

- Straight & groove forming bits
- Edge forming bits
- Laminate trimming bits
- Straight guide
- Trimmer guide assembly
- Templet guides
- Templet guide adapter
- Lock nut
- Collet cone 1/4"
- Dust nozzle
- Wrench 8
- Wrench 13
- Wrench 22

Cut



**Makita Canada Inc.
1950 Forbes Street,
Whitby, Ontario
L1N 7B7**

Stamp
Timbre

Fold

Your answers to the following questions are appreciated.

1. This product was purchased from?

- Hardware/lumber Store Industrial Supply
 Tool Distributor Other ()

3. How did you first learn of Makita Power Tools?

- Magazine/Newspaper Catalog
 From dealer Other ()
 Store display

2. Use of the product is intended for?

- Construction trade Home maintenance
 Industrial maintenance Other ()

4. Most favored points are?

- Design Makita Brand
 Features Power
 Size Other ()
 Price

5. Any comments?

Certificate of Warranty Mail to Makita

Date Purchased

Month		Day		Year 20	

Model No.

Serial No.

Initial Last Name

Male Female Single Married

--	--	--	--	--	--	--	--	--	--	--	--	--	--	--	--	--	--	--	--

Street Address

--

City

Province

--	--	--	--	--	--	--	--	--	--

Postal Code

AGE:

- Under 19 20-29 30-39 40-49 Over 50

Occupation:

Dealer's Name & Address:

Factory Service Centres

Head Office:	1950 Forbes St., Whitby, Ontario, L1N 7B7 (905) 571 - 2200	1-800-263-3734
Regional Office:	11771 Hammersmith Way, Richmond B.C. V7A 5H6 (604) 272 - 3104	1-800-663-0909
Regional Office: (Montreal)	6389 boul. Couture, St. Leonard, Quebec H1P 3J5 (514) 323 - 1223	1-800-361-7049
Dartmouth:	202 Brownlow Avenue Dartmouth, N.S., B3B 1T5 (902) 468 - 7064	1-888-625-4821
Ville St. Laurent: (Montreal)	1140 Rue Bégin, Ville St. Laurent, Quebec H4R 1X1 (514) 745 - 5025	1-888-745-5025
Les Saules: (Quebec)	1200 St. Jean Baptiste, Unit 106, Les Saules, Quebec, G2E 5E8 (418) 871 - 5720	1-800-663-5757
Nepean: (Ottawa)	203 Colonnade Road, Unit #6, Nepean, Ontario K2E 7K3 (613) 224 - 5022	1-888-560-2214
Whitby:	1950 Forbes St., Whitby, Ontario, L1N 7B7 (905) 571 - 2200	1-800-263-3734
London:	317 Adelaide St. S., Unit 117, London, Ontario, N5Z 3L3 (519) 686 - 3115	1-800-571-0899
Mississauga:	6350 Tomken Rd., Unit 8, Mississauga, Ontario, L5T 1Y3 (905) 670 - 7255	1-800-221-9811
Calgary:	#8-6115 Fourth St. S.E., Calgary Alberta, T2H 2H9 (403) 243 - 3995	1-800-267-0445
Edmonton:	11614-149 Street, Edmonton, Alberta, T5M 3R3 (780) 455 - 6644	1-888-455-6644
Richmond:	11771 Hammersmith Way, Richmond, B.C., V7A 5H6 (604) 272 - 3104	1-800-663-0909
Coquitlam:	2131 Hartley Ave., #103 Coquitlam, B.C. V3K 2Z3 (604) 525 - 7434	1-800-266-7738
Winnipeg:	1670 St. James Street, Winnipeg, Manitoba, R3H 0L3 (204) 694 - 0402	1-800-550-5073
Saskatoon:	206A-2750 Faithful Avenue Saskatoon, Saskatchewan, S7K 6M6 (306) 931 - 0111	1-888-931-0111

For the authorized service centre nearest you please refer to the local yellow pages directory under "tools" or contact our customer service department (Tel) 1-800-263-3734

When you need service...

- Explain the problem in a letter
- Enclose the letter with the tool
- Package carefully and send prepaid to the nearest Makita factory or authorized service centre

CUSTOMER RECORD

DATE
PURCHASED: _____

DEALER'S NAME
& ADDRESS: _____

MODEL NO.: _____

SERIAL NO.: _____

MAKITA LIMITED ONE YEAR WARRANTY

Warranty Policy

Every Makita tool is thoroughly inspected and tested before leaving the factory. It is warranted to be free of defects from workmanship and materials for the period of ONE YEAR from the date of original purchase. Should any trouble develop during this one-year period, return the COMPLETE tool, freight prepaid, to one of Makita's Factory or Authorized Service Centres. If inspection shows the trouble is caused by defective workmanship or material, Makita will repair (or at our option, replace) without charge.

This Warranty does not apply:

- where normal maintenance is required,
- repairs have been made or attempted by others,
- the tool has been abused, misused or improperly maintained,
- alterations have been made to the tool.

IN NO EVENT SHALL MAKITA BE LIABLE FOR ANY INDIRECT, INCIDENTAL OR CONSEQUENTIAL DAMAGES FROM THE SALE OR USE OF THE PRODUCT. THIS DISCLAIMER APPLIES BOTH DURING AND AFTER THE TERM OF THIS WARRANTY.

"The Makita Warranty is the only and the entire written warranty given by Makita for the Makita tools. No dealer or his agent or employee is authorized to extend or enlarge upon this warranty by any verbal or written statement or advertisement."

MAKITA DISCLAIMS LIABILITY FOR ANY IMPLIED WARRANTIES INCLUDING IMPLIED WARRANTIES OF "MERCHANTABILITY" AND FITNESS FOR A SPECIFIC PURPOSE," AFTER THE ONE-YEAR TERM OF THIS WARRANTY.

"This Warranty gives you specific rights. The provisions contained in this warranty are not intended to limit, modify, take away from, disclaim or exclude any warranties set forth in any provincial legislation. To the extent required by law, the provisions in any provincial or federal legislation with respect to warranties take precedence over the provisions in this warranty."

Makita Corporation
3-11-8, Sumiyoshi-cho,
Anjo, Aichi 446-8502 Japan